

### Méthode de réglage

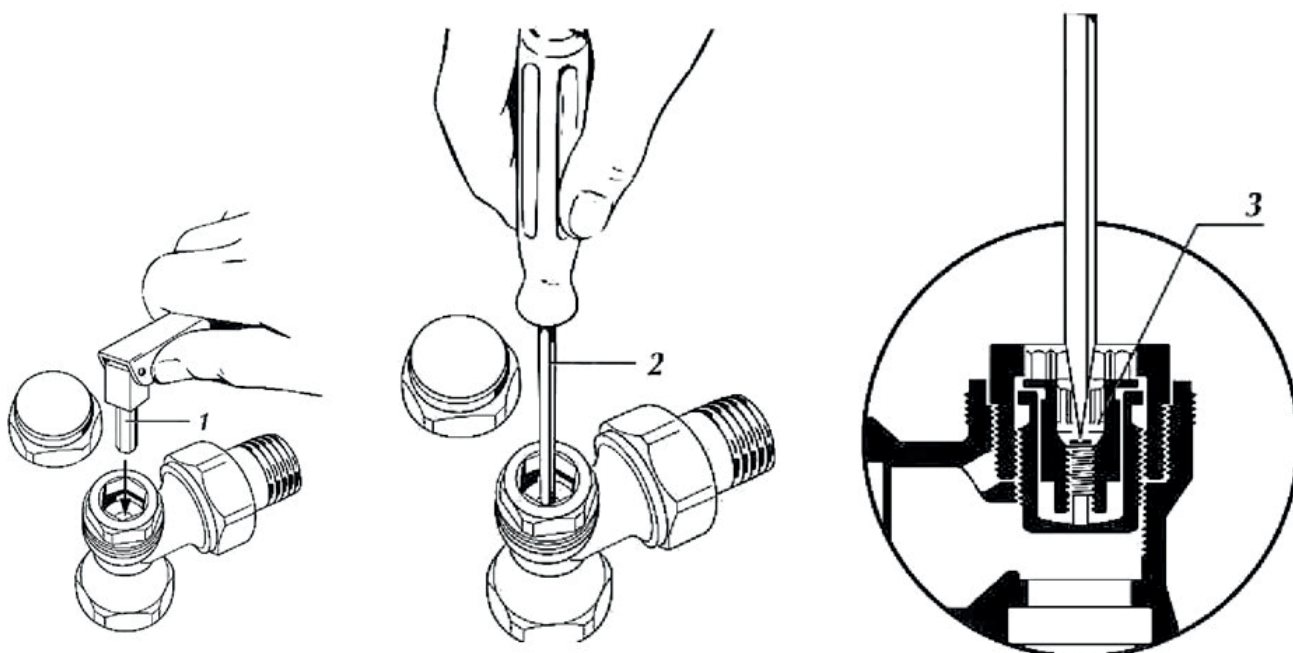

1. Retirer le bouchon. Tourner l'aiguille avec une clé adaptée (Allen ou outil 334) dans le sens horaire jusqu'à la butée.  
Dévissez (sens inverse) avec le nombre de tours requis (voir courbes), pour atteindre les résultats souhaités (valeur Kv)

2. Pour les appareils équipés de la mémoire, un tournevis plat doit être utilisé

3. Visser la vis de réglage jusqu'au bout.

### Courbes hydrauliques

2428/3428 3/8"

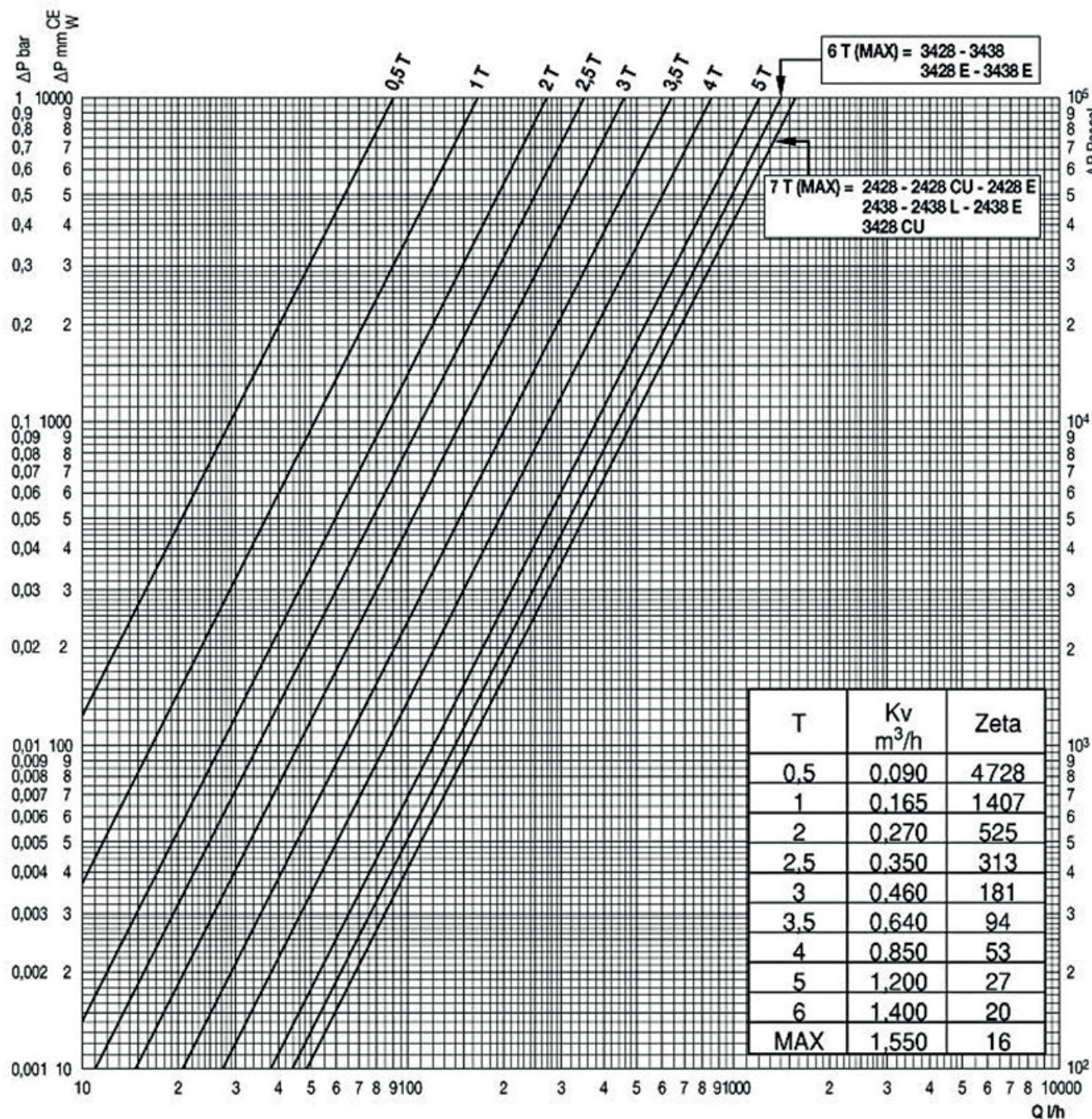

2428/3428 1/2"

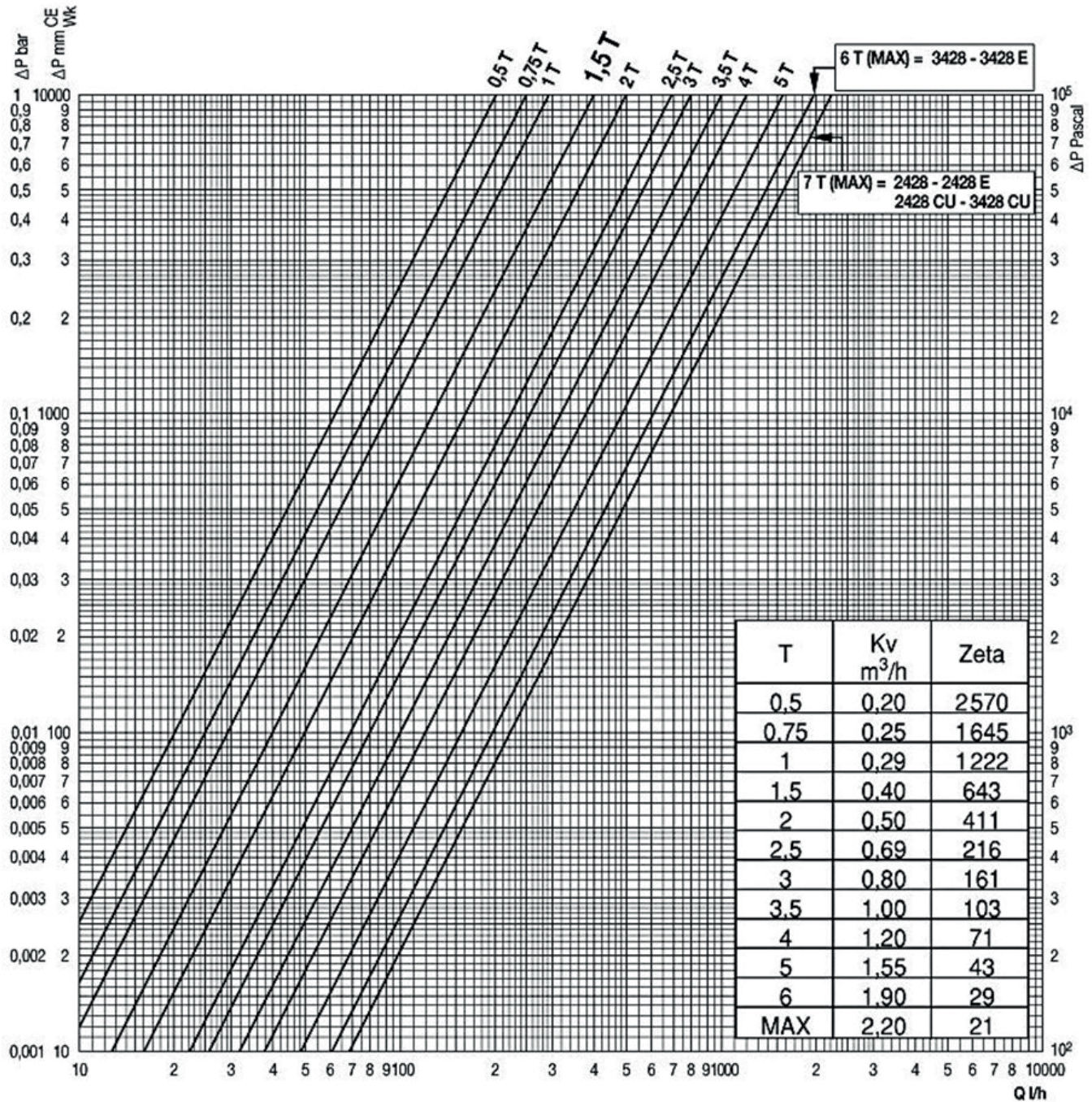

2428/3428 3/4"

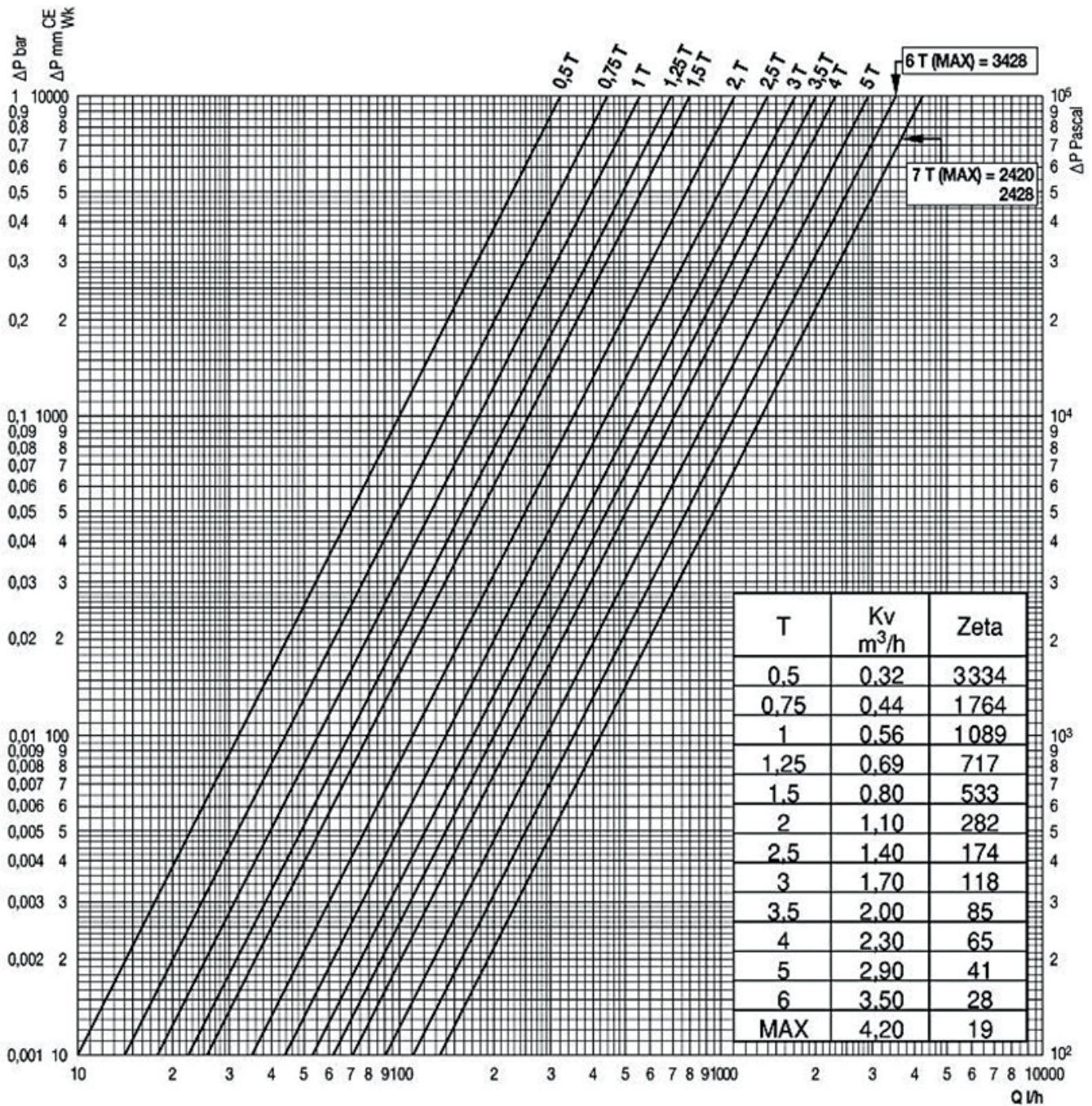

2429 3/8"

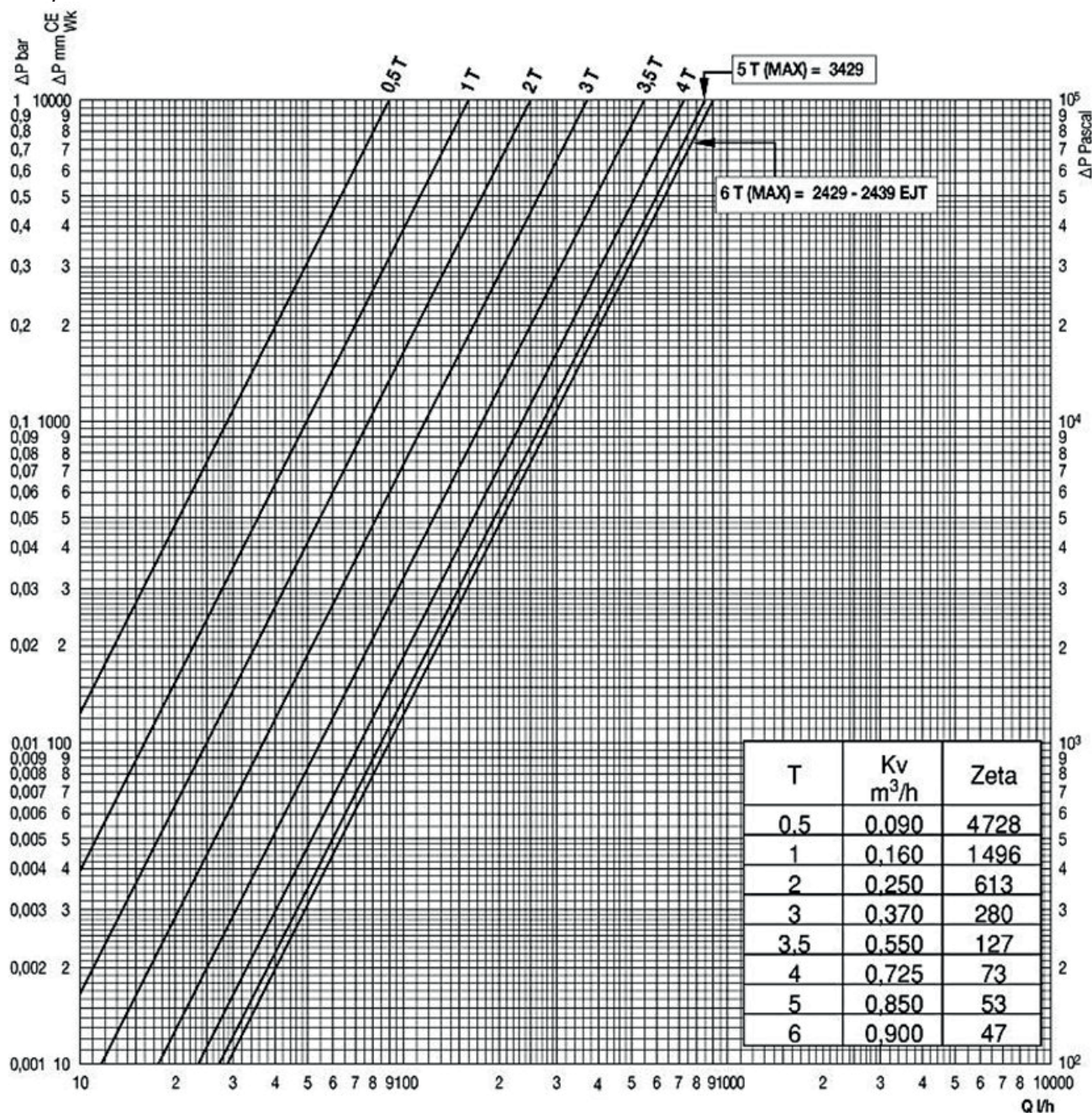

2429/3429 1/2"

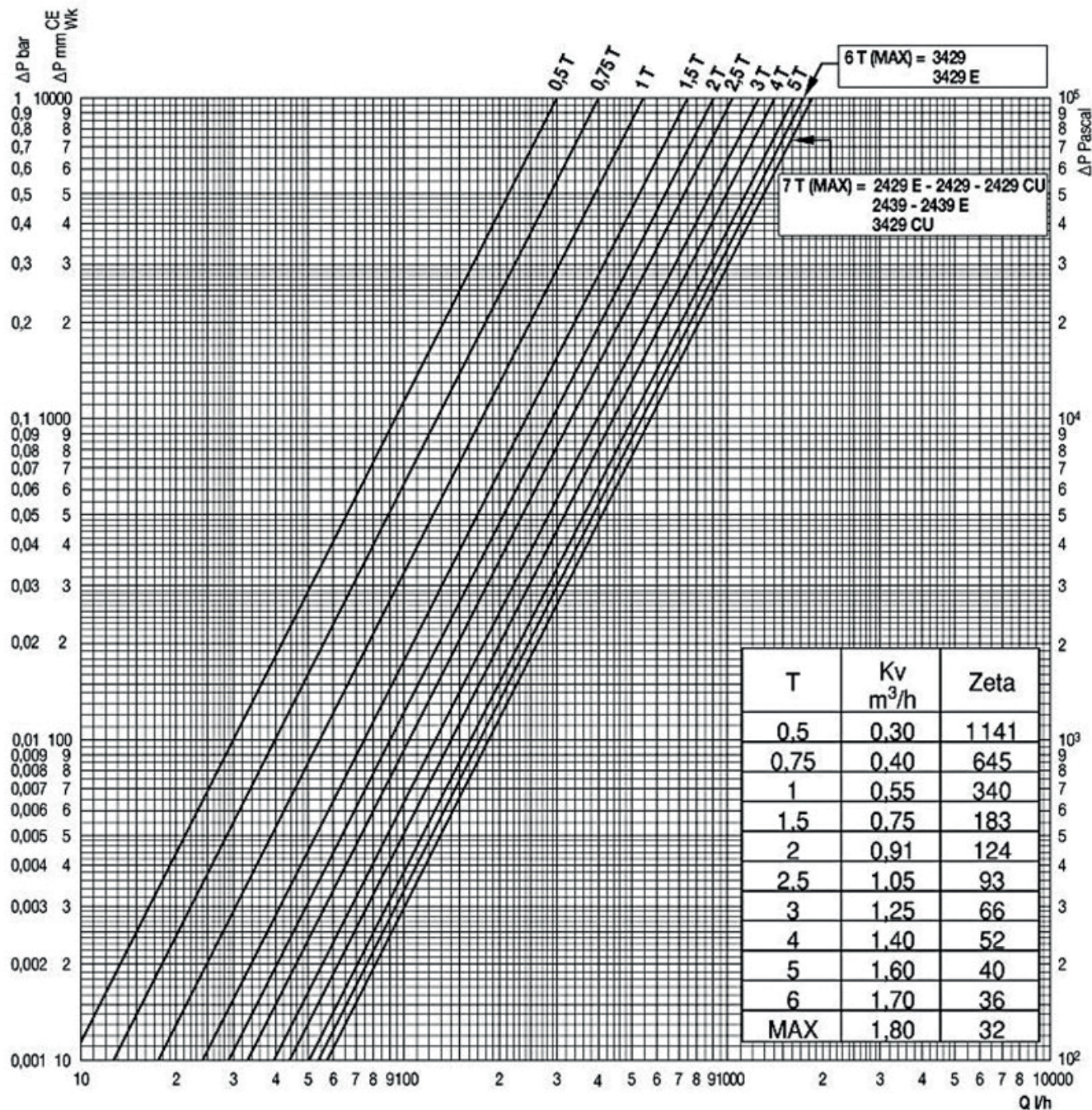

### 2429/3429 3/4"

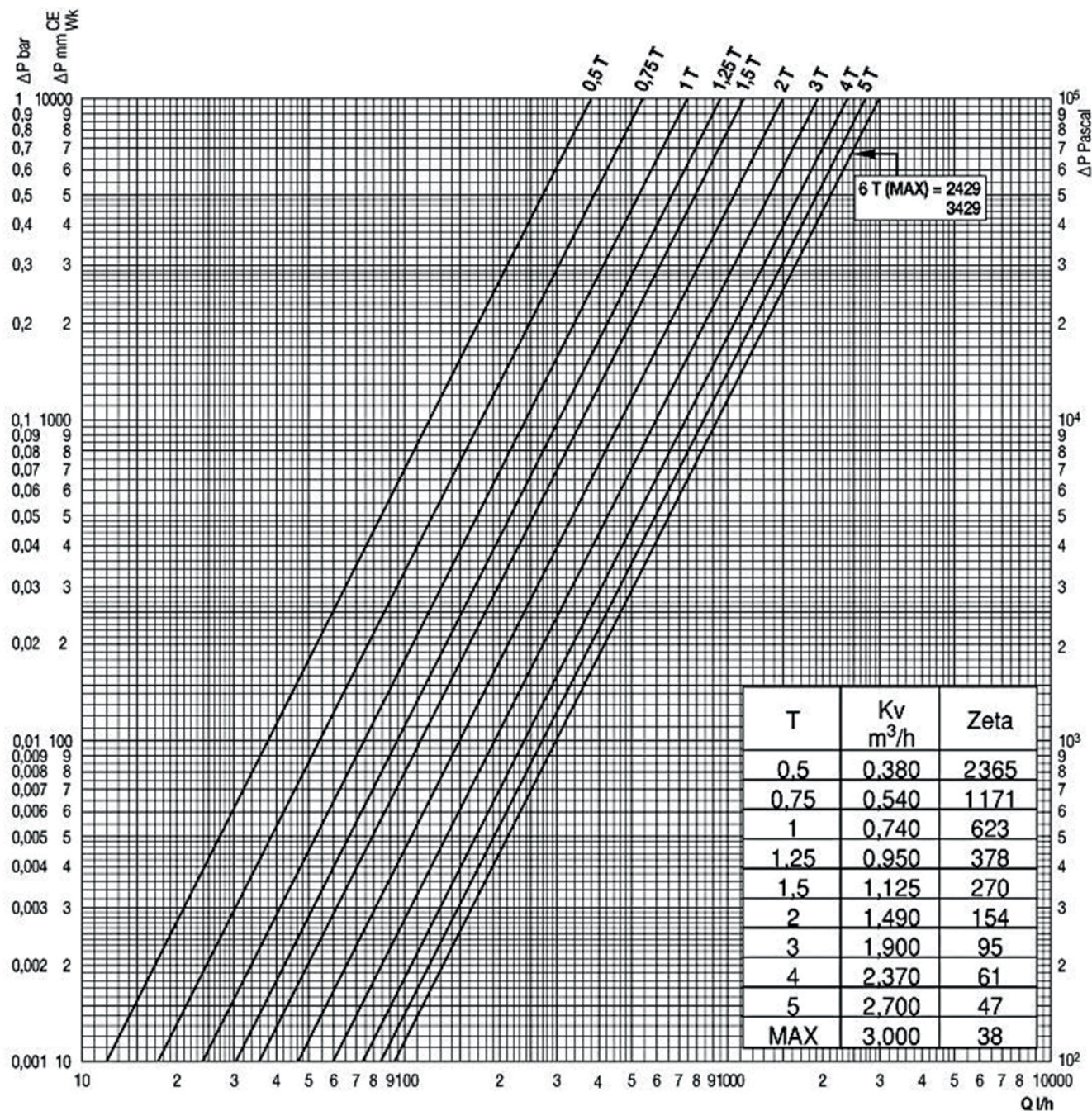

2429/3429 3/4"

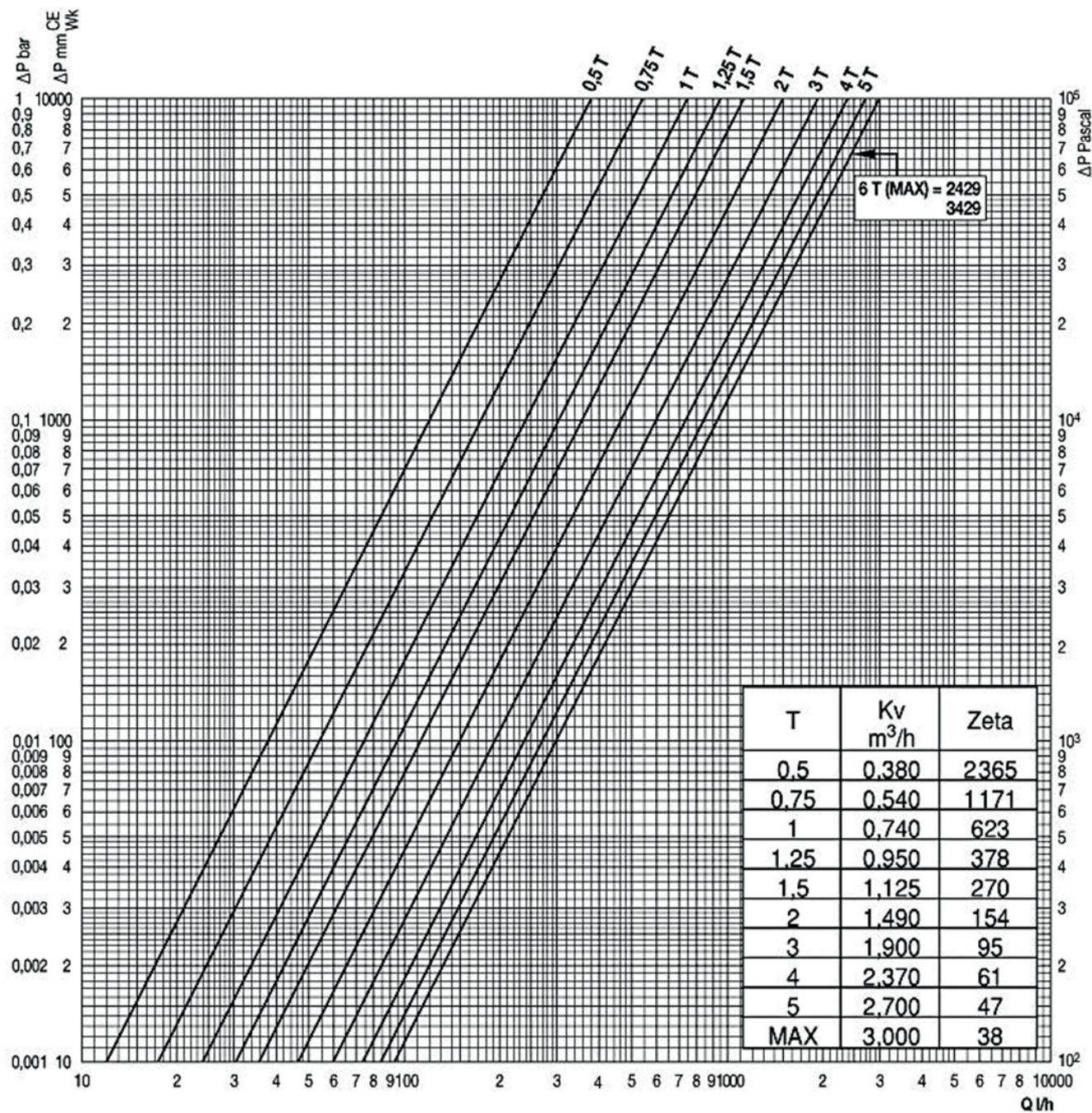



### 4468 3/8"

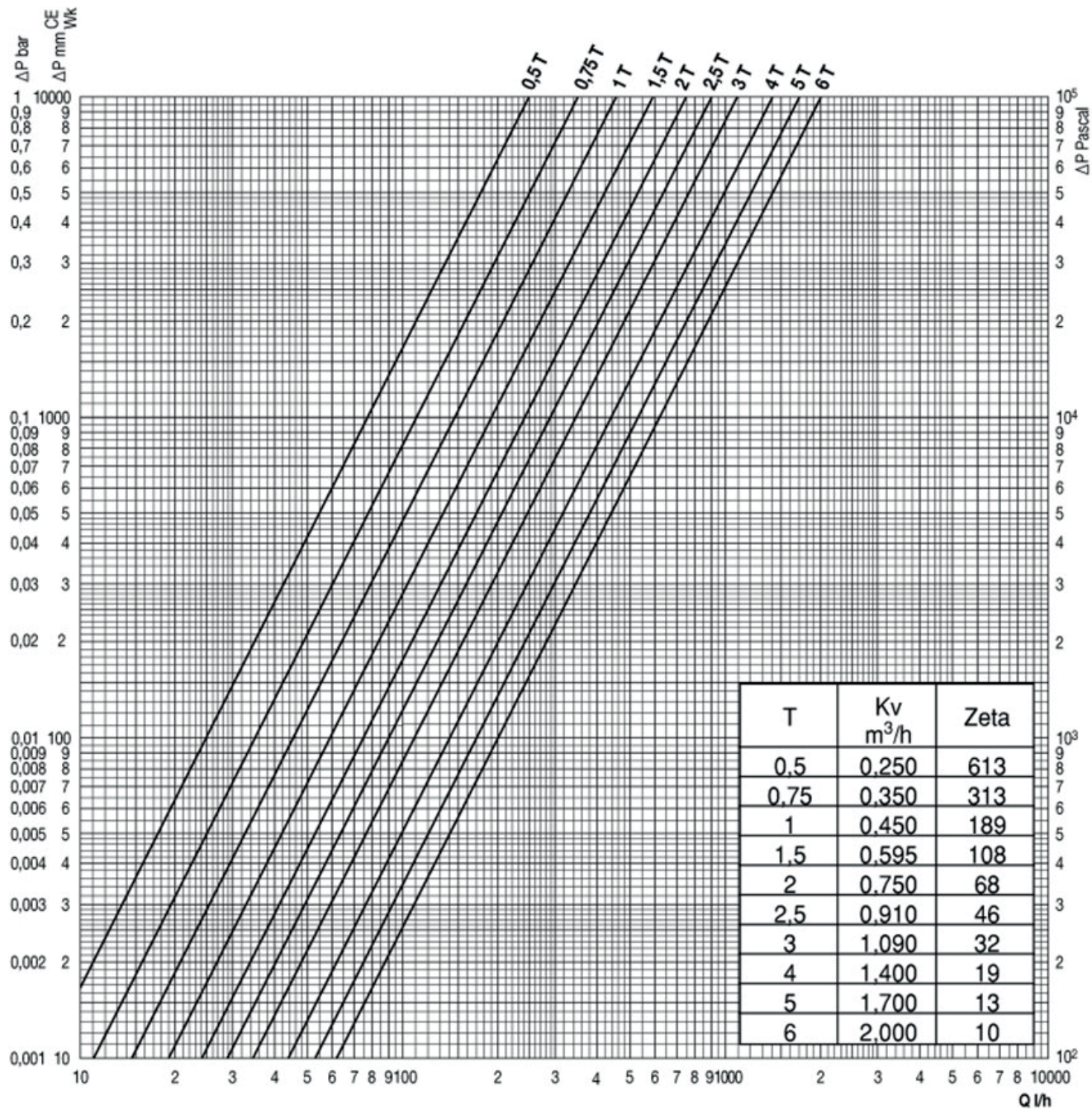

4468 1/2"

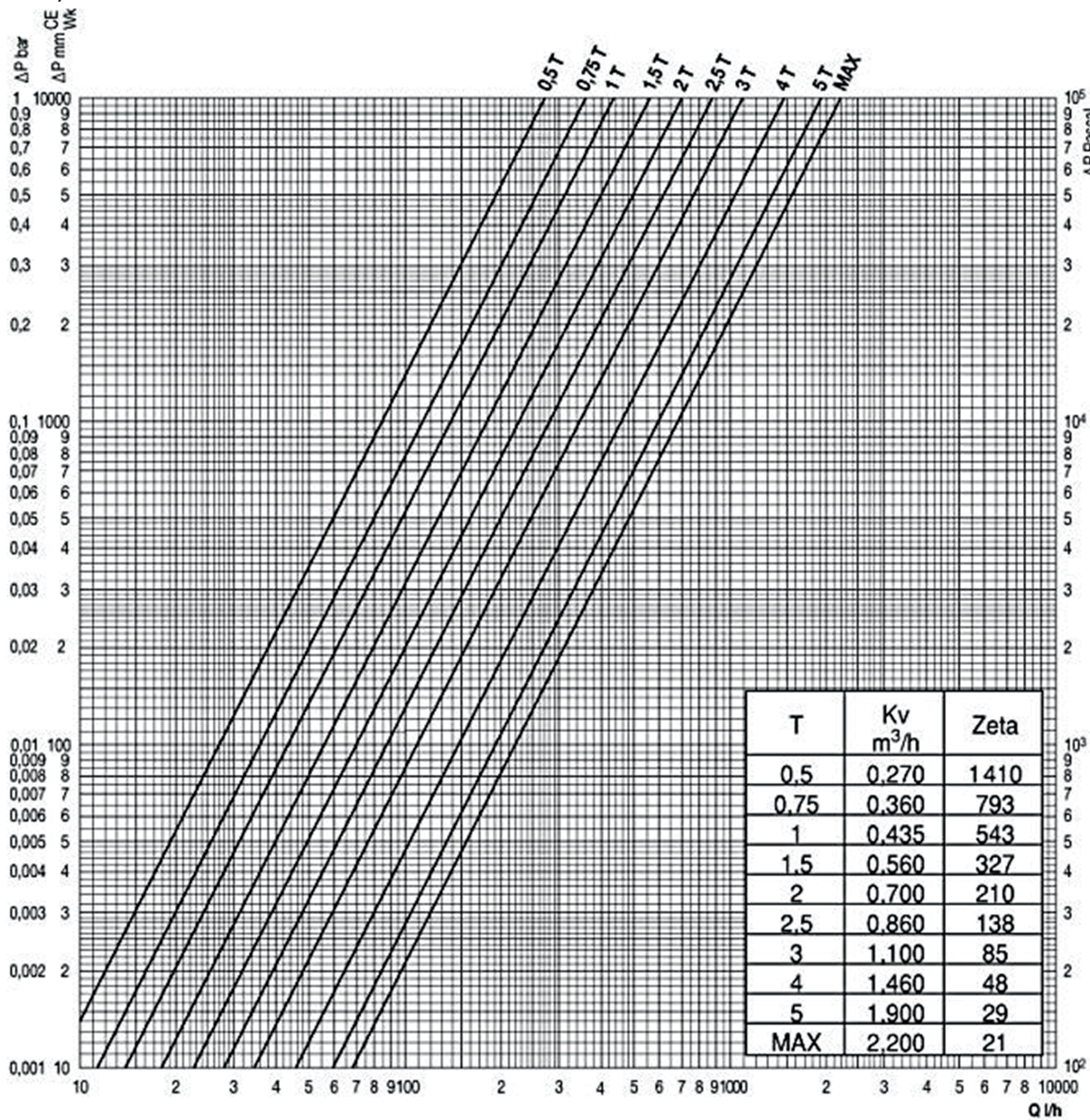

### 4468/4469 3/4"

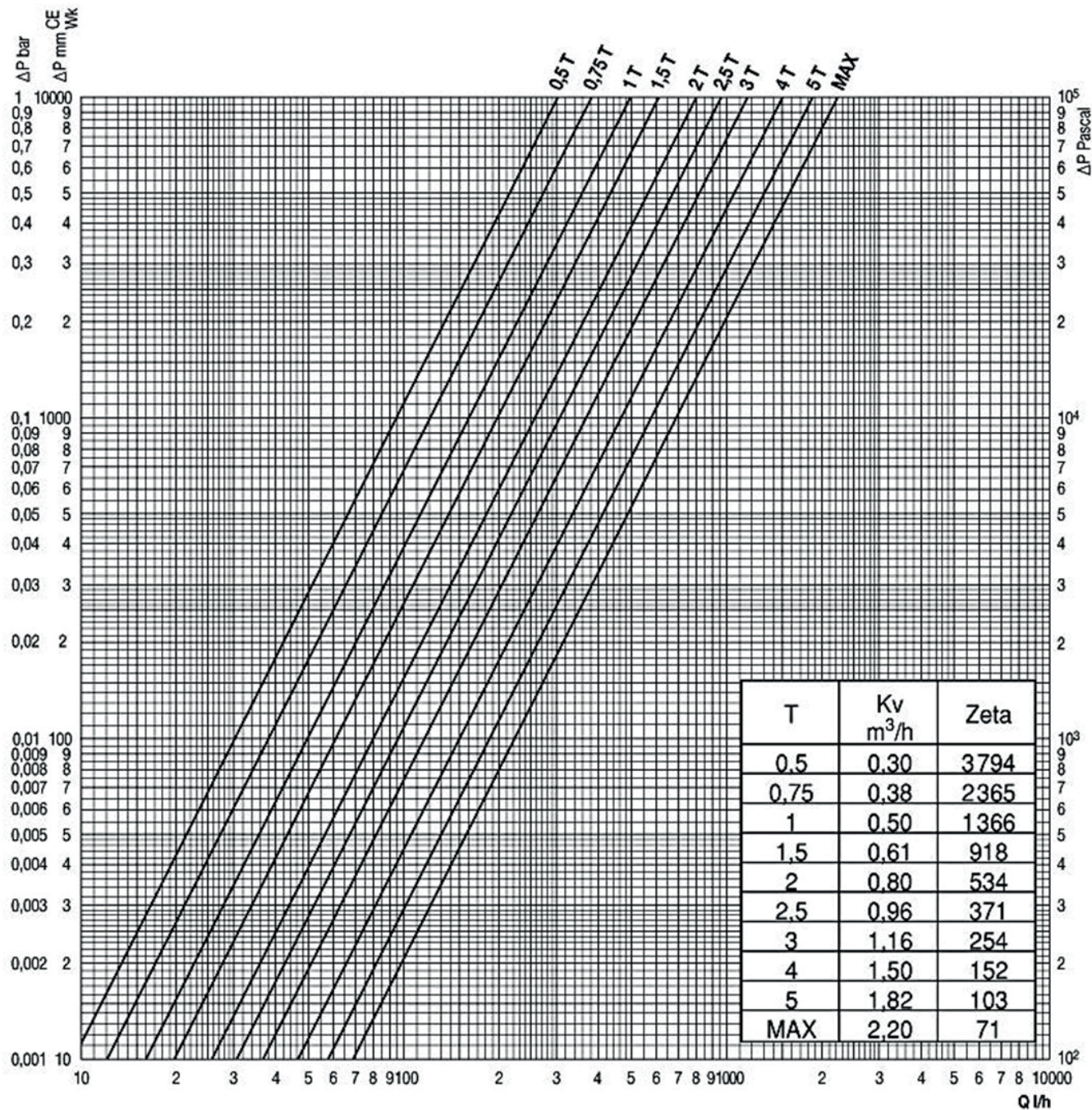

4469 3/8"

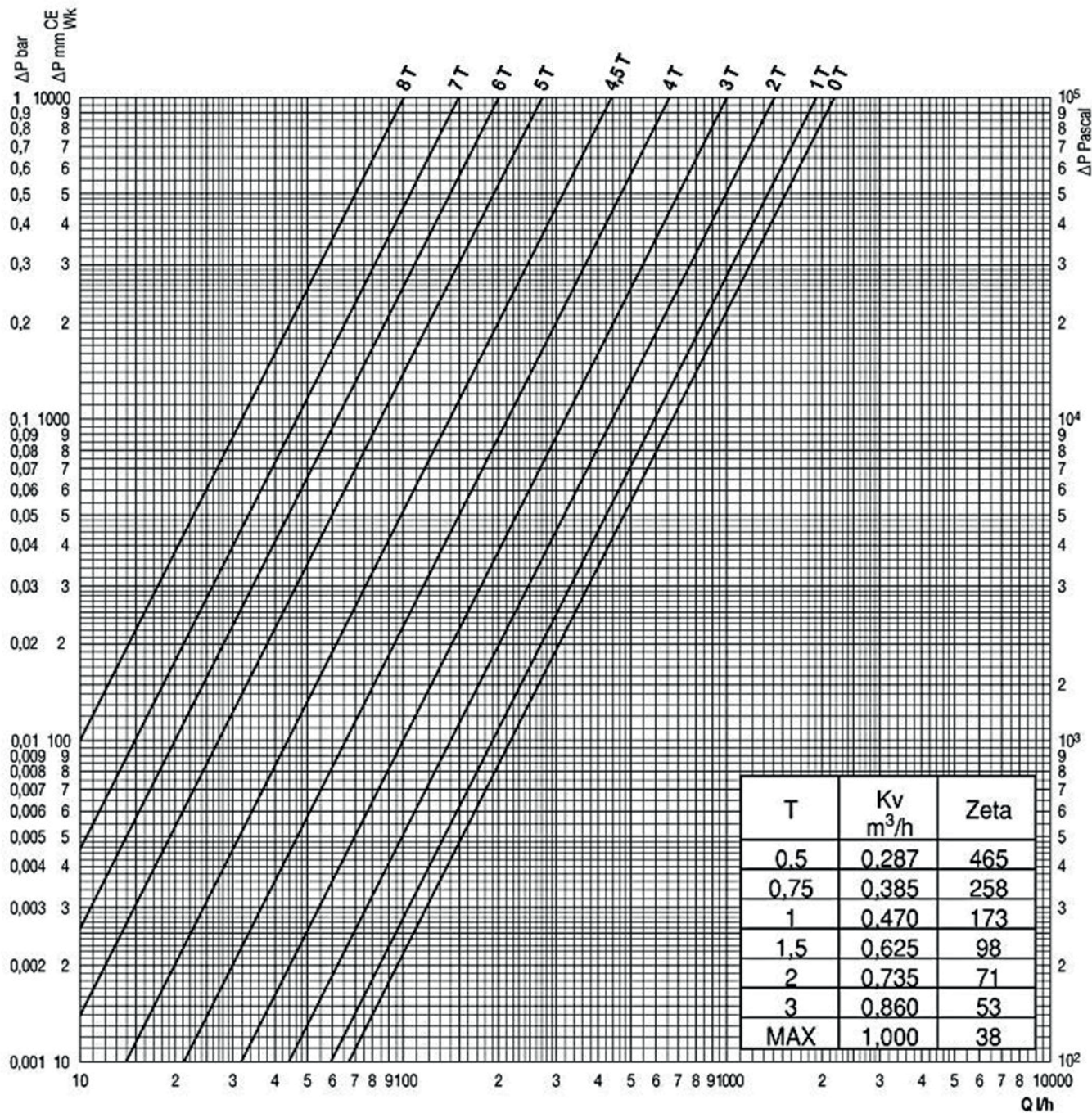

4469 1/2"

